











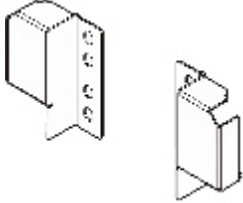
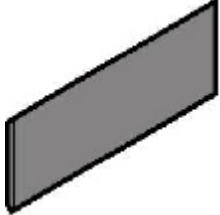

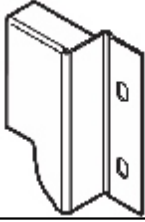

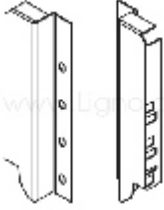

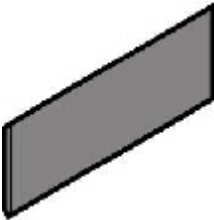

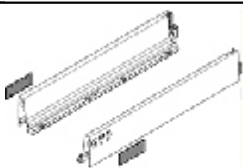

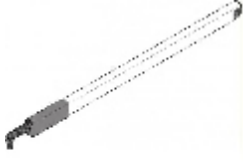
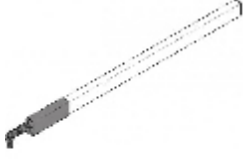
21.06.2018

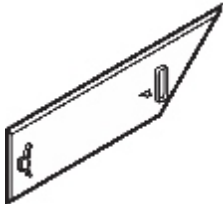
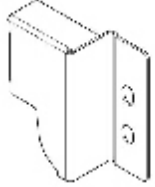



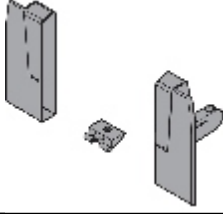
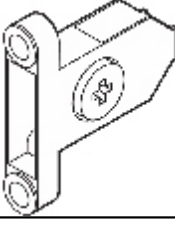
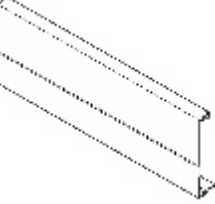

BOXIDE L450 R+L Z37H418S.E			700,00
BOXIDE L500 R+L Z37H468S.E			697,00
METABOX 450 ZRG.421V.ID.CW/C			100,00
METABOX 450*150 320H4500C			600,00
METABOX 450*150 320H4500C			600,00
METABOX 450*86 320M4500C			450,00
METABOX blumotion metabox Z70.0320			250,00
METABOX BLUM ZAA.3500.BL			10,00
METABOX R+L ZSF.1700			60,00



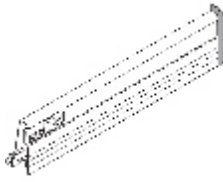

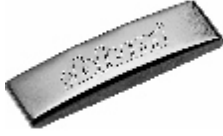

METABOX	-	H(150)	,	25	,	-450	,	320H4502C L		0,00
METABOX	-	H(150)	,	25	,	-450	,	320 4502C R		0,00
METABOX		ZRR.8000.01								35,00
METABOX			,	25	,	450	,	320M4501 L		0,00
METABOX			,	25	,	450	,	320M4501 RE		0,00
MOVENTO		T51.7601.L								120,00
MOVENTO		T51.7601.R								120,00
MOVENTO		450	,	40	,	TIP ON 760H4500M				1 900,00
MOVENTO		450	,	40	,	TIP ON 760H4500T				2 500,00
MOVENTO	TIP-ON	L3 350-750	/	(20)	T60L7540 TOB					1 100,00
TANDEM	.550		.		.	+ Biomotion 560H5500B				1 300,00
TANDEMBOX Antaro		Z36.00804								0,00
TANDEMBOX Antaro		Z36.00801								0,00
TANDEMBOX Antaro		Z36D00802 R								0,00
TANDEMBOX Antaro		Z36D00802								0,00
TANDEMBOX Antaro		()	.		.	ZRR.5200				90,00
TANDEMBOX Antaro	Intivo	BLUM								15,00
TANDEMBOX Antaro		ZAA.532C.BLABDV1000SEIW								110,00
TANDEMBOX Antaro		N . R+L	.		.	Z30N000S.04				110,00
TANDEMBOX Antaro		N . R+L	.		.	Z30N000S.04HO-RV50SEIW				0,00







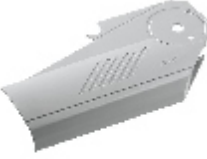

TANDEMBOX Antaro Z30M000S.04HO-RV50SEIW	. R+L . (50)		80,00
TANDEMBOX Antaro	1 . . R+L . (50) Z30B000S.04		110,00
TANDEMBOX Antaro Z30C000S.SW	1 . R+L . (50)		250,00
TANDEMBOX Antaro	2 . R+L . Z30D000S.04		180,00
TANDEMBOX Antaro	. T51.1700.04 L		50,00
TANDEMBOX Antaro	. T51.1700.04 R		50,00
TANDEMBOX Antaro V20SEIW	500 , .R+L 378M5002SA R+L		800,00
TANDEMBOX Antaro	450 , .R+L 358M4502SA Z V1 SEIW		800,00
TANDEMBOX Antaro V1 SEIW	N 450 , .R+L 358N4502SA Z R+L		1 300,00









TANDEMBOX Antaro R+L V1 SEIW	N 500 ,	.R+L (16) 378N5002SA Z		1 350,00
TANDEMBOX Antaro ZRG.387RSIC SW L	450 ()			180,00
TANDEMBOX Antaro ZRG.387RSIC SW R	450 ()			180,00
TANDEMBOX Intivo SEIW	450 ,	.R+L 378M4502SA Z L+R V20		0,00
TANDEMBOX Tip-on blum, TOB R+L V1R735	S1,NL=270-349m,10-20 ,	- T60B3130		0,00
TANDEMBOX	450	ZRG.396V.IC		150,00
TANDEMBOX	500	ZRG.446V.IC		150,00
TANDEMBOX	R+L	ZAA.230N.BL		15,00
TANDEMBOX	"N" R+L	Z30N000S.04		150,00
TANDEMBOX	R+L ,	Z30M000S.04		70,00







TANDEMBOX	R+L	2	Z30D000S		160,00
TANDEMBOX	R+L	c 1	Z30B000S.04		110,00
TANDEMBOX			ZIF.70M0 L+R		160,00
TANDEMBOX			ZSF.3502.02		30,00
TANDEMBOX			Z31A1081A		750,00
TANDEMBOX			ZRG.000E3		10,00
TANDEMBOX	"N" 500	R+L	() 378N5002S WA/G		1 200,00
TANDEMBOX	450	R+L	378M4502S		620,00
TANDEMBOX	450	R+L	(20) 378N4502S		1 200,00
TANDEMBOX	500	R+L	(20) 378M5002S		700,00
TANDEMBOX	500	R+L	(20) 378M5002S ZV20WA/G		700,00







TANDEMBOX	500	R+L	(20) 378N5002S			1 200,00
TANDEMBOX	500	R+L	(20) 378M5002S			700,00
TANDEMBOX+	. Blumotion 450	R+L	578.4501B			900,00
TANDEMBOX+	. Blumotion 500	R+L	578.5001B			820,00
TIP-ON TIP-ON 250R 736			- 956 1002			320,00
TIP-ON 250SEIW			956.1002TIP ON			300,00
TIP-ON 956.1002TIP-ON 250R736			-			270,00
TIP-ON			955.1008S			8,00
			CLIP TOP (70.1503.BP			7,00
	1/2	. 107,120	. 70.1663			10,00
	1/2	. 107,120	. 70.1663			10,00
	170	. 973A6000				150,00









HK	20 8001.02 L		.	100,00
HK	, 20K8001.02 L SW		.	210,00
HK	20K8001.02 R		.	100,00
HK	, 20K8001.02 R SW		.	210,00
HK-S	20K8A01		.	100,00
HK-S	20K8A01 (.)		.	150,00
HK-S	20 8 01 R		.	100,00
HK-S	, 20 8 01 (.)		.	150,00
HL	(20) 20L8001.02 L		.	0,00
HL	20L8001.01.L (. .)		.	0,00
HL	(20) 20L8001.02 R		.	0,00
HL	, 20L8001.01.R (. .)		.	0,00
	HS 20 20S8001.L		.	100,00
	S 20 20S8001.R		.	100,00
	BLUM (HF*HS*HL) 20F9001.BL			25,00









20Q0003.03			10,00
blum 20 9001. L.L			30,00
blum 20K9001.BL.R			30,00
(HF), (HGR) (20) 20F8001			80,00
(HF), (HGR) (20) 20F8001			80,00
HF 20F8001 L			130,00
HF 20F8001 R			130,00
BLUM TANDEMBOX 450 M -			1 500,00
, AVENTOS HK-XS, (200) 20K5101			40,00





AVENTOS HK-X 20K4101			30,00
.HS*HK*HL 20S4201			100,00
Clip 110 (86 .) 70T3553			0,00
.BLUMOTION 170 973 6000			150,00
71B3550 70T3504			10,00
CLIP top BLUMOTION 110 71B3550			130,00
CLIP top BLUMOTION 110 (250) 71B3750			190,00
CLIP top BLUMOTION 110 71B3650			190,00
CLIP top BLUMOTION 79B9550			270,00
Clip +45° , 78 5550			220,00

Clip 120°	70T5550.T		90,00
Clip 170	71T6550		230,00
Clip	(50) 78T9550.TL		300,00
. Clip top	78Z5500T		180,00
CLIP top	BLUMOTION +45 79B9658		270,00
Clip Expando	174E6100.01		20,00
Clip	173L6100		10,00
Clip	() 175H3100		30,00
Clip	() 177H3100E		60,00
TIP ON	955,1008S		9,00
-	- AVENTOS HK-XS - HK-XSTIP-ON500-1200 20K1301T		0,00

-	- AVENTOS HK-XS, 20K1301		600,00
	250 955.1008D		10,00
	ZIF.7007		370,00
=450-580	HL 20L3901.06.R		1 300,00
	HS 20S3501.06L		1 000,00
	HS 20S3501.06 R		1 000,00
	480-570 () 20F3201.01		650,00
	560-710 () 20F3501.01		750,00
	700-900 () 20F3801.01		850,00
	760-1040 () 20F3901.01		900,00
/	HK -XS 800-1800 20K1501		650,00

/ HK -XS TIP-ON,800-1600 TIP-ON 20K1501T			750,00
/ HK 1500-4900 SERVODRIVE 20K2701.05			1 200,00
/ HK 3200-9000 SERVODRIVE 20K2901.05			1 800,00
/ () -S 20 2 01.02			600,00
/ 6-13.5 (S) SERVODRIVE 20S2H01.05			1 500,00
/ KM 1500-4900 (SERVO-DRIVE) (20K2701.05			1 150,00
/ KM 750-2500 (SERVO-DRIVE) (20K2501.05			1 150,00
/ KM 750-2500 TIP-ON 20K2501T			0,00
/ LF=5.350-10.150 (SERVO-DRIVE) (20F2501.05			1 400,00
/ LF=9000-17,250(SERVO-DRIVE) 20F2801.05			1 600,00

HL 25	SERVODRIVE 20L2501.05			1 700,00
HL 27	SERVODRIVE 20L27017.05			0,00
	(40) FLV01SP			100,00
700	() SGV70VCP			680,00
800	() (20) SGV80VM20CP			680,00
900	() (20) SGV90VM20CP			700,00
700	() SGV70PCP			600,00
900	() SGV90PM20CP			650,00
700	(20) VA700			800,00
900	VA900M20			850,00
1061	20Q1061UN			420,00

L 20 20L8001.02.L		.	100,00
L 20 20L8001.02 R		.	100,00
HL 200 20Q003A01		.	30,00
=450-580 HL 20L3901.06.L		.	1 300,00
L=1061 20Q1061UA		.	800,00