

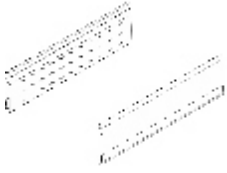

































29.04.2022







BOXIDE L450 R+L	Z37H418S.E			1 386,00
BOXIDE L500 R+L	Z37H468S.E			1 617,00
HF	(HGR) (20) 20F8001			207,90
HF	(HGR) (20) 20F8001			207,90
HF	20F8001 L			242,55
HF	20F8001 R			242,55
HF	480-570 () 20F3201.01			1 501,50
HF	560-710 () 20F3501.01TE-HEB V40 NI			1 651,65
HF	700-900 () 20F3801.01T E-HEB V40			1 674,75
HF	760-1040 () 20F3901.01			1 732,50
HF25 20 ZN	/ LF=5.350-10.150 (SERVO-DRIVE) (20F2501.05KRAFTSP			2 425,50



HF28	/ LF=9000-17,250(SERVO-DRIVE) 20F2801.05		.	2 656,50
HK	20 8001.02 L		.	231,00
HK	, 20K8001.02 L SW		.	242,55
HK	20K8001.02 R		.	231,00
HK	, 20K8001.02 R SW		.	242,55
HK	blum 20 9001. L.L		.	75,08
HK	blum 20K9001.BL.R		.	75,08
HK	/ KM 0750-2500 (SERVO-DRIVE) (20K2501.05		.	2 252,25
HK	/ KM 1500-4900 (SERVO-DRIVE) (20K2701.05		.	2 367,75
HK	/ KM 3200-9000 SERVODRIVE 20K2901.05		.	3 234,00
HK	/ TIP-ON KM 3200-7800 20K2901T		.	4 158,00
HK	/ TIP-ON KM 750-2500 20K2501T		.	2 656,50

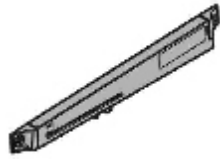

HK	/	1500-4900	SERVODRIVE 20K2701.05		.	2 367,75
HK-S		20K8A01			.	115,50
HK-S		20K8A01	ABD L V40SEIW		.	173,25
HK-S			20K9001ABD V500SEIW		.	0,00
HK-S		20 8 01 R			.	115,50
HK-S			20K8A01 ABD R V40SEIW		.	173,25
HK-S	/	(C) c TIP ON	20K2C01T		.	1 270,50
HK-S	/	()	20 2 01.02		.	1 270,50
HK-S	/	()	c TIP ON 20K2E01T		.	1 270,50
HK-S	/	()	(40) 20 2C01.02KRA FTSP 40 ZN		.	1 270,50
HK-XS			AVENTOS, (200) 20K5101			92,40

HK-XS	20K4101			92,40
HK-XS	/ 500-1500 20K1301			1 270,50
HK-XS	/ 800-1800 20K1501			1 270,50
HK-XS	/ TIP-ON, 800-1600 20K1501T			1 270,50
HL 25	SERVODRIVE 20L2501.05			1 848,00
HL 27	SERVODRIVE 20L27017.05			1 963,50
HL	20 20L8001.02.L			115,50
HL	20L8001.01.L (. .)			150,15
HL	20 20L8001.02 R			115,50
HL	20L8001.01.R (. .)			150,15
HL	200 20Q003A01			34,65

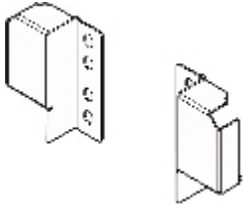
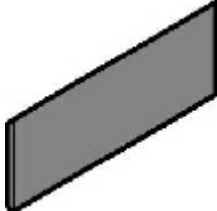
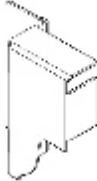
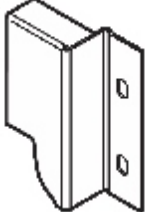

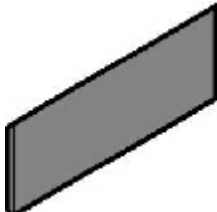

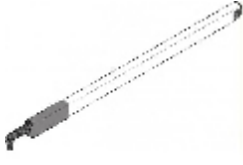
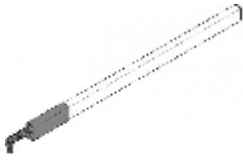
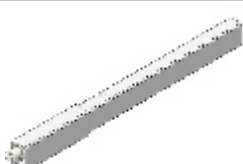
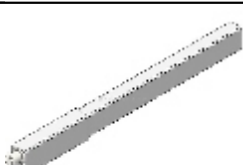
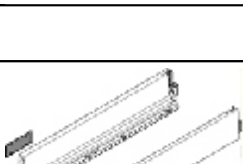
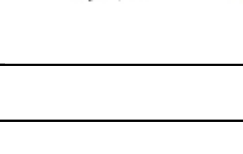

HL	=450-580	20L3901.06.L			1 501,50
HL	=450-580	20L3901.06.R			1 501,50
HL		L=1061	20Q1061UA		924,00
HS		20 20S8001.L			115,50
HS		20 20S8001.R			115,50
HS		20Q0003.03			17,32
HS	/ 4.0-8.0	SERVODRIVE 20S2G01.05			2 194,50
METABOX	450	ZRG.421V.ID.CW/C			115,50
METABOX	450*150	320H4500C			693,00





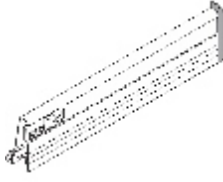

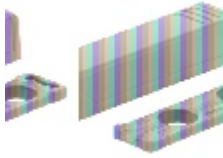
METABOX 450*150 320H4500C		.	693,00
METABOX 450*86 320M4500C		.	519,75
METABOX blumotion metabox Z70.0320		.	311,85
METABOX BLUM ZAA.3500.BL		.	11,55
METABOX R+L ZSF.1700		.	69,30
METABOX - H(150), . 25 , -450, , 320H4502C L		.	0,00
METABOX - H(150), . 25 , -450, , 320 4502C R		.	0,00
METABOX ZRR.8000.01		.	40,42
METABOX , . ,25 , 450 , 320M4501 L		.	0,00
METABOX , . ,25 , 450 , 320M4501 RE		.	0,00
MOVENTO T51.7601.L		.	138,60
MOVENTO T51.7601.R		.	138,60
MOVENTO 450 , 40 , TIP ON 760H4500M		.	2 887,50
MOVENTO 450 , 40 , TIP ON 760H4500T		.	3 465,00
MOVENTO TIP-ON L3 350-750 / (20) T60L7540 TOB R+LV1R737		.	1 270,50
TANDEMBOX 450 R+L 358N4502S		.	0,00
TANDEMBOX Antaro Z36.00804		.	11,55
TANDEMBOX Antaro Z36.00801		.	11,55
TANDEMBOX Antaro Z36D00802 R		.	51,98
TANDEMBOX Antaro Z36D00802 L		.	51,98







TANDEMBOX Antaro () . ZRR.5200			225,22
TANDEMBOX Antaro Intivo BLUM ZAA.532C.BLABDV1000SEIW			17,32
TANDEMBOX Antaro D . R+L . (50) Z30D000S HO-R L+R V50 W			254,10
TANDEMBOX Antaro N . R+L . Z30N000S.04			173,25
TANDEMBOX Antaro . R+L . (50) Z30M000S.04HO-RL V50 W			150,15
TANDEMBOX Antaro . R+L . (50) Z30M000S.04HO-RV50SEIW			150,15
TANDEMBOX Antaro 1 . R+L . (50) Z30B000S.04			288,75
TANDEMBOX Antaro 1 . R+L . (50) Z30C000S HO-RW MP W			288,75
TANDEMBOX Antaro . T51.1700.04 L			57,75
TANDEMBOX Antaro . T51.1700.04 R			57,75





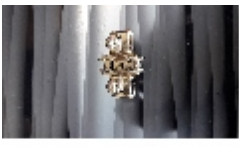

TANDEMBOX Antaro V1 SEIW	N 450	, .R+L 358N4502SA Z R+L		.	2 021,25
TANDEMBOX Antaro R+L V1 SEIW	N 500	, .R+L (16) 378N5002SA Z		.	2 079,00
TANDEMBOX Antaro ZRG.387RSIC SW L	450	()		.	288,75
TANDEMBOX Antaro ZRG.387RSIC SW R	450	()		.	288,75
TANDEMBOX Antaro ZRG.437RSIC SW L	500	()		.	300,30
TANDEMBOX Antaro ZRG.437RSIC SW R	500	()		.	300,30
TANDEMBOX Antaro/intivo L+R V1 SEIW	450	, .R+L 378M4502SA Z		.	1 732,50
TANDEMBOX Antaro/intivo V20SEIW	500	, .R+L 378M5002SA R+L		.	1 848,00
TANDEMBOX Tip-on blum, TOB R+L V1R735	S1,NL=270-349m,10-20	, - T60B3130		.	1 097,25
TANDEMBOX	450	ZRG.396V.ICREL LAE100/WA/G		.	173,25

TANDEMBOX	500	ZRG.446V.IC			173,25
TANDEMBOX WELLE V 40 S	Tip-on	1400 , .6 , 1118	T60L1118W		346,50
TANDEMBOX	R+L	ZAA.230N.BL			20,79
TANDEMBOX	"N" R+L	Z30N000S.04			173,25
TANDEMBOX	D R+L	(50) Z30D000S HO R R+L V50R906			254,10
TANDEMBOX	R+L ,	Z30M000S.04			138,60
TANDEMBOX	R+L ,	Z30M000S.04			138,60
TANDEMBOX	R+L 2	Z30D000S			254,10
TANDEMBOX	R+L	Z30B000S			138,60
TANDEMBOX	R+L	c 1 . Z30B000S.04			127,05
TANDEMBOX	.	. INSERTA ZSF.3902			115,50
TANDEMBOX	.	ZIF.70M0 FRO R+L V1R737		0	519,75
TANDEMBOX	.	ZSF 3502.02FROB V500 BL			57,75
TANDEMBOX		ZIF.7007			750,75
TANDEMBOX		ZRG.000E3			11,55

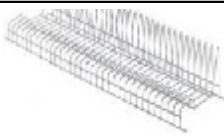
TANDEMBOX	450	R+L	378M4502S			1 501,50
TANDEMBOX	450	R+L	(20) 378N4502S			1 732,50
TANDEMBOX	500	R+L	(20) 378N5002S			1 848,00
TANDEMBOX	500	R+L	(20) 378M5002S			1 732,50
TIP ON TIP-AP 250SCEIW			(20/32) 956A1201			173,25
TIP ON TIP-AP 250R736			(20/32) 956A1201			173,25
TIP ON TIP-AP 250R736			(20/17) 956.1201			115,50
TIP ON			956A1002TIP-ON 250R736			496,65
TIP-ON			955.1008 HPL-KL 250 BL			34,65
TIP-ON			955.1008D HPL-DR 250 NI			23,10
TIP-ON TIP-ON 250R 736			- 956 1002			496,65
TIP-ON 250SEIW			956.1002TIP ON			381,15
			BLUM (HF*HS*HL) . 20F9001.BL			57,75
			.HS*HK*HL 20S4201			138,60

	Clip 110 (86 .) 70T3553			46,20
. BLUMOTION	170 973 6000			184,80
	CLIP TOP (11,55
70.1503.BPABD PR1000 NI	1/2 . 107,120 . 70.1663			11,55
	1/2 . 107,120 . 70.1663			11,55
	170 . 973A6000			184,80
	. Clip top B(. 70T3504 TO-AB			16,94
1000 NI	71B3550 70T3504			11,55
CLIP top BLUMOTION 110	71B3550			334,95
CLIP top BLUMOTION 110	(250) 71B3750			334,95
CLIP top BLUMOTION 110	71B3650			334,95
CLIP top BLUMOTION	. 95 79B9550 MB V50 NI			635,25

CLIP top	110		70T3550.TL		173,25
Clip +45°			78 5550		277,20
Clip 120°			70T5550.T		184,80
Clip 170			71T6550		288,75
Clip t. 110			71T3550 MB V250 NI		161,70
. Clip top			78Z5500T		334,95
CLIP top			BLUMOTION +45 79B9658		519,75
Clip Expando			174E6100.01		35,00
Clip			173L6100 MPL V500 NI		29,26
Clip	Expando		HK-S/HF 177H3100E DUEPL		80,85
V500 NI			(40) FLVO1SP		207,90
	1000	()	(20) SVG100VCP		2 079,00
	600	()	(20) SGV60VM20CP		1 559,25
	700	()	SGV70VCP		1 674,75

800	() (20) SGV80VM20CP			1 674,75
1000	() SGV100PCP			2 079,00
600	() (20) SGV60PM20CP			1 559,25
700	() SGV70PCP			1 674,75
800	() (20) SGV80PM20CP			1 674,75
1000	VA1000			2 425,50
700	(20) VA700			1 848,00
800	VA800M20			2 079,00
600	VP600M20			924,00
800	VP800M20			1 039,50