

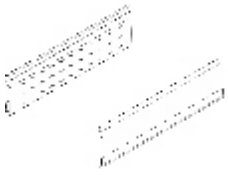





































10.09.2021





BOXIDE L450 R+L	Z37H418S.E			644,95
BOXIDE L500 R+L	Z37H468S.E			763,25
HF	(HGR) (20) 20F8001			0,00
HF	(HGR) (20) 20F8001			84,40
HF	20F8001 L			105,50
HF	20F8001 R			105,50
HF	480-570 ( ) 20F3201.01			569,69
HF	560-710 ( ) 20F3501.01TE-HEB V40 NI			0,00
HF	700-900 ( ) 20F3801.01			0,00
HF	700-900 ( ) 20F3801.01T E-HEB V40			0,00
HF	760-1040 ( ) 20F3901.01			569,69
HF22 20 ZN	/ LF=2.600-5.550 ( SERVO-DRIVE) 20F2201.05KR AFTSP			0,00
HF25 20 ZN	/ LF=5.350-10.150 ( SERVO-DRIVE) ( 20F2501.05KRAFTSP			0,00



HF28	/ LF=9000-17,250( SERVO-DRIVE) 20F2801.05		.	1 427,75
HK	20 8001.02 L		.	91,44
HK	, 20K8001.02 L SW		.	0,00
HK	20K8001.02 R		.	91,44
HK	, 20K8001.02 R SW		.	0,00
HK	blum 20 9001. L.L		.	0,00
HK	/ KM 0750-2500 ( SERVO-DRIVE) ( 20K2501.05		.	903,10
HK	/ KM 1500-4900 ( SERVO-DRIVE) ( 20K2701.05		.	940,66
HK	/ KM 3200-9000 SERVODRIVE 20K2901.05		.	1 716,11
HK	/ 1500-4900 SERVODRIVE 20K2701.05		.	940,66
HK-S	20K8A01		.	67,66

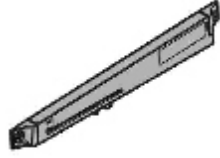

HK-S	20K8A01 ABD L V40SEIW		0,00
HK-S	20K9001ABD V500SEIW		0,00
HK-S	20 8 01 R		67,66
HK-S	20K8A01 ABD R V40SEIW		0,00
HK-S	/ (C) c TIP ON 20K2C01T		601,68
HK-S	/ ( ) 20 2 01.02		491,62
HK-S	/ ( ) c TIP ON 20K2E01T		601,68
HK-S	/ ( ) (40) 20 2C01.02KRA FTSP 40 ZN		0,00
HK-XS	AVENTOS, (200) 20K5101		35,97
HK-XS	20K4101		24,45
HK-XS	/ 500-1500 20K1301		540,57
HK-XS	/ 800-1800 20K1501		568,33
HK-XS	/ TIP-ON 500-1500 20K1301T		0,00

HK-XS	/ TIP-ON, 800-1600 20K1501T		.	611,49
HL 25	SERVODRIVE 20L2501.05		.	1 511,85
HL 27	SERVODRIVE 20L27017.05		.	1 587,45
HL	20 20L8001.02.L		.	94,95
HL	20L8001.01.L ( . . )		.	115,89
HL	20 20L8001.02 R		.	94,95
HL	, 20L8001.01.R ( . . )		.	115,89
HL	. 200 20Q003A01		.	18,74
HL	=450-580 20L3901.06.L		.	996,76
HL	=450-580 20L3901.06.R		.	1 228,34
HL	. L=1061 20Q1061UA		.	725,58

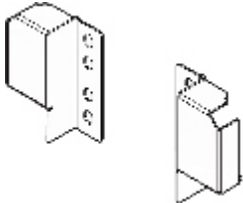
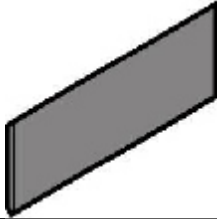
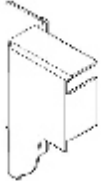
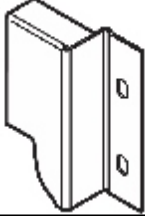
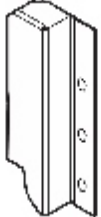

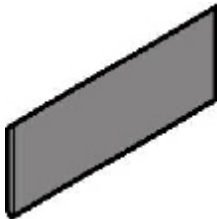

HS	20 20S8001.L			94,95
HS	20 20S8001.R			94,95
HS	20Q0003.03			9,14
HS	20S3501.06L			835,55
HS	20S3501.06 R			905,88
HS	/ 4.0-8.0 SERVODRIVE 20S2G01.05			1 283,21
HS	/ 6-13.5 SERVODRIVE 20S2H01.05			1 283,21
HS	1061 20Q1061UN			452,81
METABOX	450 ZRG.421V.ID.CW/C			94,44

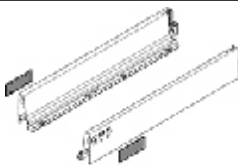
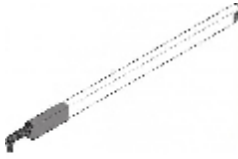
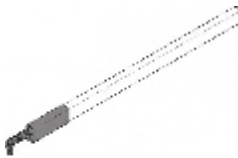
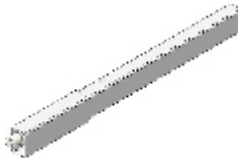
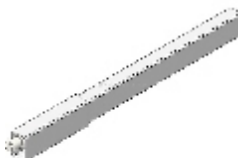



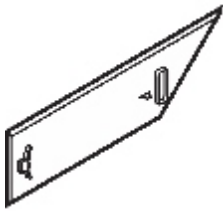
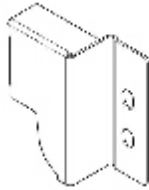

METABOX 450*150 320H4500C		.	517,44
METABOX 450*150 320H4500C		.	519,79
METABOX 450*86 320M4500C		.	393,60
METABOX blumotion metabox Z70.0320		.	205,37
METABOX BLUM ZAA.3500.BL		.	8,04
METABOX R+L ZSF.1700		.	47,53
METABOX - H(150 ), . 25 , -450, , 320H4502C L		.	223,30
METABOX - H(150 ), . 25 , -450, , 320 4502C R		.	223,30
METABOX ZRR.8000.01		.	27,44
METABOX , . ,25 , 450 , 320M4501 L		.	38,19
METABOX , . ,25 , 450 , 320M4501 RE		.	38,19
MOVENTO T51.7601.L		.	101,94
MOVENTO T51.7601.R		.	101,94
MOVENTO 450 , 40 , TIP ON 760H4500M		.	1 691,92
MOVENTO 450 , 40 , TIP ON 760H4500T		.	2 395,81
MOVENTO TIP-ON L3 350-750 / (20) T60L7540 TOB R+LV1R737		.	972,56



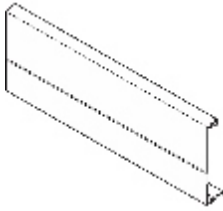

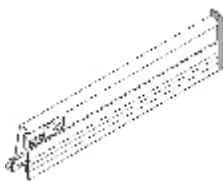

TANDEMBOX	450	R+L	358N4502S			0,00
TANDEMBOX Antaro			Z36.00804			6,38
TANDEMBOX Antaro			Z36.00801			6,38
TANDEMBOX Antaro Z36D00802 R						32,92
TANDEMBOX Antaro L			Z36D00802			32,92
TANDEMBOX Antaro	( )		ZRR.5200			75,92
TANDEMBOX Antaro	Intivo		BLUM			8,74
TANDEMBOX Antaro	D . R+L		(50) Z30D000S HO-R L+R			0,00
TANDEMBOX Antaro	N . R+L		Z30N000S.04			97,06
TANDEMBOX Antaro	. R+L		(50) Z30M000S.04HO-RL			0,00
TANDEMBOX Antaro	. R+L		(50)			0,00
TANDEMBOX Antaro	1	. R+L	(50) Z30B000S.04			95,66
TANDEMBOX Antaro	1	. R+L	(50) Z30C000S			0,00
TANDEMBOX Antaro			T51.1700.04 L			43,48

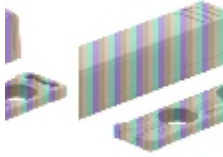





TANDEMBOX Antaro		T51.1700.04 R		43,48
TANDEMBOX Antaro SEIW	450	.R+L 378M4502SA Z L+R V1		754,82
TANDEMBOX Antaro V20SEIW	500	.R+L 378M5002SA R+L		0,00
TANDEMBOX Antaro V1 SEIW	N 450	.R+L 358N4502SA Z R+L		1 311,04
TANDEMBOX Antaro R+L V1 SEIW	N 500	.R+L (16) 378N5002SA Z		1 395,56
TANDEMBOX Antaro ZRG.387RSIC SW L	450	( )		177,50
TANDEMBOX Antaro ZRG.387RSIC SW R	450	( )		177,50
TANDEMBOX Antaro ZRG.437RSIC SW L	500	( )		179,52
TANDEMBOX Antaro ZRG.437RSIC SW R	500	( )		179,52
TANDEMBOX Intivo SEIW	500	.R+L 378M5002SA Z R+L V1		0,00









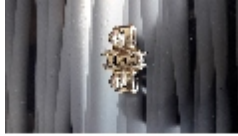

TANDEMBOX Tip-on blum, TOB R+L V1R735	S1,NL=270-349m,10-20 , -	T60B3130		0,00
TANDEMBOX	450	ZRG.396V.ICREL LAE100/WA/G		0,00
TANDEMBOX	500	ZRG.446V.IC		138,55
TANDEMBOX WELLE V 40 S	Tip-on 1400 , .6 , 1118	T60L1118W		234,17
TANDEMBOX	R+L ZAA.230N.BL			14,74
TANDEMBOX	"N" R+L	Z30N000S.04		123,92
TANDEMBOX	D R+L	(50) Z30D000S HO R R+L V50R906		0,00
TANDEMBOX	R+L ,	Z30M000S.04		0,00
TANDEMBOX	R+L ,	Z30M000S.04		78,48
TANDEMBOX	R+L 2	Z30D000S		154,37
TANDEMBOX	R+L	Z30B000S		0,00
TANDEMBOX	R+L	c 1 . Z30B000S.04		100,33
TANDEMBOX MP ZN	blumotion 30 ,	450 ,R+L 578.4501B K R+L		0,00
TANDEMBOX MP ZN	blumotion 30 ,	500 ,R+L 578.5001B K R+L		0,00
TANDEMBOX	.	INSERTA ZSF.3902		0,00
TANDEMBOX	.	ZIF.70M0 FRO R+L V1R737	0	0,00
TANDEMBOX	.	ZSF 3502.02FROB V500 BL		0,00

TANDEMBOX			Z31A1081A			705,43
TANDEMBOX			ZIF.7007			364,33
TANDEMBOX			ZRG.000E3			7,04
TANDEMBOX	450	R+L	378M4502S			583,16
TANDEMBOX	450	R+L	(20) 378N4502S			1 107,04
TANDEMBOX	500	R+L	(20) 378N5002S			1 092,87
TANDEMBOX	500	R+L	(20) 378M5002S			597,39
TANDEMBOX+	Blumotion 500	R+L	578.5001B			0,00
TIP ON			(20/32) 956A1201			0,00
TIP-AP 250SCEIW						
TIP ON			(20/32) 956A1201			102,74
TIP-AP 250R736						
TIP ON			(20/17) 956.1201			97,73
TIP-AP 250R736						
TIP ON			956A1002TIP-ON 250R736			0,00
TIP-ON			955.1008 HPL-KL 250 BL			0,00
TIP-ON			955.1008D HPL-DR 250 NI			0,00
TIP-ON			- 956 1002			308,13
TIP-ON 250R 736						

TIP-ON TIP-ON 250SEIW	956A1002		0,00
TIP-ON 250SEIW	956.1002TIP ON		244,28
TIP-ON 956.1002TIP-ON 250R736			256,83
BLUM (HF*HS*HL)	20F9001.BL		21,11
.HS*HK*HL 20S4201			77,60
Clip 110 ( 86 )	70T3553		32,02
. BLUMOTION 170 973 6000			135,18
CLIP TOP (			0,00
70.1503.BPABD PR1000 NI			
1/2 . 107,120 . 70.1663			7,50
1/2 . 107,120 . 70.1663			7,42
170 . 973A6000			129,27
. Clip top B(	70T3504 TO-AB		0,00
1000 NI			
71B3550 70T3504			9,14

CLIP top BLUMOTION 110	71B3550		118,56
CLIP top BLUMOTION 110	(250) 71B3750		168,69
CLIP top BLUMOTION 110	71B3650		168,69
CLIP top BLUMOTION . 95	79B9550 MB V50 NI		0,00
CLIP top 110	, , 70T3550.TL		82,30
Clip +45°	, 78 5550		180,86
Clip 120°	70T5550.T		84,40
Clip 170	71T6550		180,85
Clip t. 110	. . 71T3550 MB V250 NI		0,00
Clip	95 78T9550.TL		0,00
. Clip top	78Z5500T		175,84

CLIP top BLUMOTION +45 79B9658				278,52
				
Clip Expando 174E6100.01				17,58
				
Clip 173L6100				7,68
				
Clip ( ) 175H3100 MPL V500				0,00
Clip Expando V500 NI HK-S/HF 177H3100E DUEPL				0,00
(40) FLVO1SP				0,00
450 ( ) SGV45VM20 CP				0,00
700 ( ) SGV70VCP				617,30
				
900 ( ) (20) SGV90VM20CP				639,21
450 ( ) SGV45PM20 CP				0,00
700 ( ) SGV70PCP				544,54
				
900 ( ) SGV90PM20CP				567,22
				
1000 VA1000				0,00
700 (20) VA700				728,69
				

800	VA800M20		691,63
900	VA900M20		775,35
450	VP450M20		0,00
600	VP600M20		455,64
800	VP800M20		516,39