

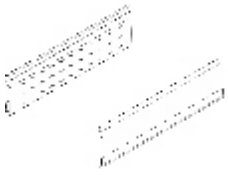



































13.10.2020

BOXIDE L450 R+L	Z37H418S.E		1 200,00
BOXIDE L500 R+L	Z37H468S.E		1 400,00
HF	(HGR) (20) 20F8001		170,00
HF	(HGR) (20) 20F8001		170,00
HF	20F8001 L		180,00
HF	20F8001 R		180,00
HF	480-570 ( ) 20F3201.01		1 250,00
HF	560-710 ( ) 20F3501.01TE-HEB V40 NI		1 250,00
HF	700-900 ( ) 20F3801.01		1 300,00
HF	700-900 ( ) 20F3801.01		1 300,00



HF	760-1040 ( ) 20F3901.01		.	1 350,00
HF22 20 ZN	/ LF=2.600-5.550 ( SERVO-DRIVE) 20F2201.05KR AFTSP		.	1 750,00
HF25	/ LF=5.350-10.150 ( SERVO-DRIVE) ( 20F2501.05		.	2 050,00
HF25 20 ZN	/ LF=5.350-10.150 ( SERVO-DRIVE) ( 20F2501.05KRAFTSP		.	2 050,00
HF28	/ LF=9000-17,250( SERVO-DRIVE) 20F2801.05		.	1 950,00
HK	20 8001.02 L		.	200,00
HK	20K8001.02 R		.	200,00
HK	blum 20 9001. L.L		.	60,00
HK	blum 20K9001.BL.R		.	60,00
HK	/ KM 0750-2500 ( SERVO-DRIVE) ( 20K2501.05		.	1 800,00







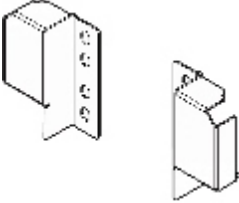
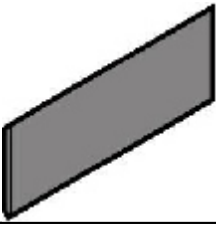
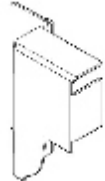

HK	/ KM 3200-9000	SERVODRIVE 20K2901.05		2 800,00
HK	/ TIP-ON KM 0750-2500	20K2501T		1 800,00
HK	/ 1500-4900	SERVODRIVE 20K2701.05		1 800,00
HK-S	20K8A01			100,00
HK-S	20K8A01 ABD L	V40SEIW		150,00
HK-S	20 8 01 R			100,00
HK-S	20K8A01 ABD R	V40SEIW		150,00
HK-S	/ (C) c TIP ON	20K2C01T		900,00
HK-S	/ ( ) 20 2 01.02			900,00
HK-S	/ ( ) c TIP ON	20K2E01T		900,00
HK-S	/ ( ) (40) 20 2C01.02	KRA FTSP 40 ZN		850,00
HK-XS	, AVENTOS, (200)	20K5101		60,00

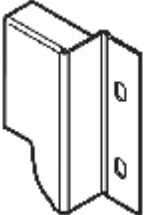
HK-XS	20K4101		.	60,00
HK-XS	/ 500-1500 20K1301		.	850,00
HK-XS	/ 800-1800 20K1501		.	850,00
HK-XS	/ TIP-ON 500-1500 20K1301T		.	900,00
HK-XS	/ TIP-ON, 800-1600 20K1501T		.	950,00
HL 25	SERVODRIVE 20L2501.05		.	1 600,00
HL 27	SERVODRIVE 20L27017.05		.	1 700,00
HL	20 20L8001.02.L		.	100,00
HL	20L8001.01.L ( . . )		.	130,00
HL	20 20L8001.02 R		.	100,00
HL	20L8001.01.R ( . . )		.	130,00
HL	200 20Q003A01		.	30,00

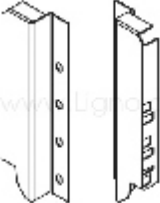

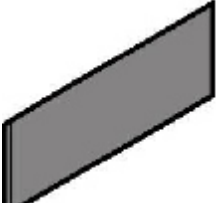
HL	=450-580	20L3901.06.L			1 300,00
HL	=450-580	20L3901.06.R			1 300,00
HL		L=1061	20Q1061UA		800,00
HS		20 20S8001.L			100,00
HS		20 20S8001.R			100,00
HS		20Q0003.03			15,00
HS		20S3501.06L			1 450,00
HS		20S3501.06 R			1 450,00





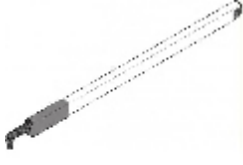
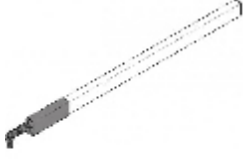
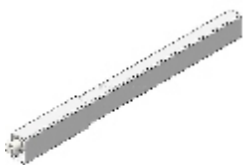
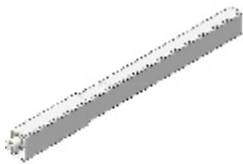
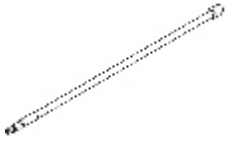

HS	/ 4.0-8.0	SERVODRIVE 20S2G01.05		.	1 900,00
HS	/ 6-13.5	SERVODRIVE 20S2H01.05		.	1 900,00
HS		1061 20Q1061UN		.	550,00
METABOX	450	ZRG.421V.ID.CW/C			100,00
METABOX	450*150	320H4500C		.	600,00
METABOX	450*150	320H4500C		.	600,00
METABOX	450*86	320M4500C			450,00
METABOX blumotion	metabox	Z70.0320			230,00
METABOX	BLUM	ZAA.3500.BL		.	10,00



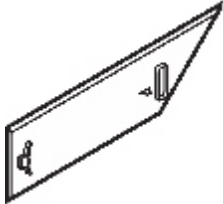

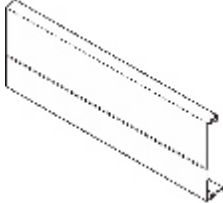

METABOX	R+L ZSF.1700		60,00
METABOX	- H(150 ), . 25 , -450, , 320H4502C L		0,00
METABOX	- H(150 ), . 25 , -450, , 320 4502C R		0,00
METABOX	ZRR.8000.01		35,00
METABOX	, . ,25 , 450 , 320M4501 L		0,00
METABOX	, . ,25 , 450 , 320M4501 RE		0,00
MOVENTO	T51.7601.L		120,00
MOVENTO	T51.7601.R		120,00
MOVENTO	450 , 40 , TIP ON 760H4500M		1 900,00
MOVENTO	450 , 40 , TIP ON 760H4500T		2 500,00
MOVENTO	TIP-ON L3 350-750 / (20) T60L7540 TOB		1 100,00
TANDEMBOX	450 R+L 358N4502S		0,00
TANDEMBOX Antaro	Z36.00804		10,00
TANDEMBOX Antaro	Z36.00801		10,00
TANDEMBOX Antaro	Z36D00802 R		35,00
TANDEMBOX Antaro	Z36D00802 L		35,00
TANDEMBOX Antaro	( ) . . ZRR.5200		195,00
TANDEMBOX Antaro	Intivo BLUM		15,00
TANDEMBOX Antaro	D . R+L . (50) Z30D000S HO-R L+R		220,00
TANDEMBOX Antaro	N . R+L . Z30N000S.04		150,00
TANDEMBOX Antaro	. R+L . (50) Z30M000S.04HO-RL		110,00





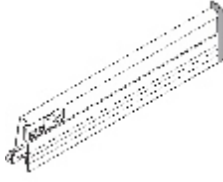

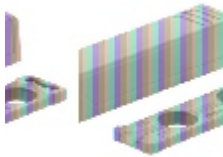
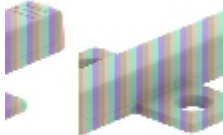
TANDEMBOX Antaro Z30M000S.04HO-RV50SEIW	. R+L . (50)			110,00
TANDEMBOX Antaro	1 . . R+L . (50) Z30B000S.04			110,00
TANDEMBOX Antaro HO-RW MP W	1 . R+L . (50) Z30C000S			0,00
TANDEMBOX Antaro Z30C000S.SW	1 . R+L . (50)			250,00
TANDEMBOX Antaro	T51.1700.04 L			50,00
TANDEMBOX Antaro	T51.1700.04 R			50,00
TANDEMBOX Antaro V20SEIW	500 , .R+L 378M5002SA R+L			1 550,00
TANDEMBOX Antaro	450 , .R+L 358M4502SA Z V1 SEIW			1 450,00
TANDEMBOX Antaro V1 SEIW	N 450 , .R+L 358N4502SA Z R+L			1 300,00















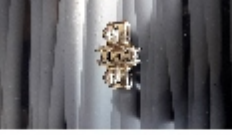

TANDEMBOX Antaro R+L V1 SEIW	N 500 ,	.R+L (16) 378N5002SA Z		1 550,00
TANDEMBOX Antaro ZRG.387RSIC SW L	450 ( )			250,00
TANDEMBOX Antaro ZRG.387RSIC SW R	450 ( )			250,00
TANDEMBOX Antaro ZRG.437RSIC SW L	500 ( )			260,00
TANDEMBOX Antaro ZRG.437RSIC SW R	500 ( )			260,00
TANDEMBOX Intivo SEIW	500 ,	.R+L 378M5002SA Z R+L V1		1 550,00
TANDEMBOX Tip-on blum, TOB R+L V1R735	S1,NL=270-349m,10-20 ,	- T60B3130		950,00
TANDEMBOX	450	ZRG.396V.ICREL LAE100/WA/G		150,00
TANDEMBOX	500	ZRG.446V.IC		150,00
TANDEMBOX WELLE V 40 S	Tip-on 1400 , .6 , 1118	T60L1118W		300,00



TANDEMBOX	R+L ZAA.230N.BL			18,00
TANDEMBOX	"N" R+L Z30N000S.04			150,00
TANDEMBOX	D R+L (50) Z30D000S HO R R+L V50R906			220,00
TANDEMBOX	R+L , Z30M000S.04			120,00
TANDEMBOX	R+L 2 . Z30D000S			220,00
TANDEMBOX	R+L Z30B000S			120,00
TANDEMBOX	R+L c 1 . Z30B000S.04			110,00
TANDEMBOX MP ZN	blumotion 30 , 450 ,R+L 578.4501B K R+L			1 100,00
TANDEMBOX MP ZN	blumotion 30 , 500 ,R+L 578.5001B K R+L			1 200,00
TANDEMBOX	. INSERTA ZSF.3902			100,00
TANDEMBOX	. . ZIF.70M0 FRO R+L V1R737		0	450,00
TANDEMBOX	. . ZSF 3502.02FROB V500 BL			35,00
TANDEMBOX	. . Z31A1081A			800,00
TANDEMBOX	ZIF.7007			450,00
TANDEMBOX	ZRG.000E3			10,00

TANDEMBOX	450	R+L	378M4502S		.	1 100,00
TANDEMBOX	450	R+L	(20) 378N4502S		.	1 200,00
TANDEMBOX	500	R+L	(20) 378N5002S		.	1 200,00
TANDEMBOX	500	R+L	(20) 378M5002S		.	1 000,00
TIP ON TIP-AP 250R736	,	,	, - .(20/32) 956A1201		.	150,00
TIP ON TIP-AP 250R736	,	,	, - .(20/17) 956.1201		.	100,00
TIP-ON	955.1008	HPL-KL 250	BL		.	30,00
TIP-ON	955.1008D	HPL-DR 250	NI		.	20,00
TIP-ON	-	956	1002		.	390,00
TIP-ON TIP-ON 250R 736	-	956	1002		.	430,00
TIP-ON 956.1002TIP-ON 250R736	-				.	300,00

BLUM (HF*HS*HL) .20F9001.BL			50,00
.HS*HK*HL 20S4201			100,00
Clip 110 ( 86 .) 70T3553			35,00
.BLUMOTION 170 973 6000			160,00
CLIP TOP (			10,00
70.1503.BPABD PR1000 NI			10,00
1/2 .107,120 . 70.1663			10,00
170 .973A6000			160,00
. Clip top B( . 70T3504 TO-AB			15,00
1000 NI			
CLIP top BLUMOTION 110 71B3550			230,00
CLIP top BLUMOTION 110 (250) 71B3750			260,00
CLIP top BLUMOTION 110 71B3650			260,00

CLIP top BLUMOTION	79B9550			430,00
CLIP top	110 , , 70T3550.TL			150,00
Clip +45°	, 78 5550			240,00
Clip 120°	70T5550.T			160,00
Clip 170	71T6550			250,00
Clip t. 110	. . . 71T3550 MB V250 NI			140,00
Clip	(50) 78T9550.TL			300,00
. Clip top	78Z5500T			290,00
CLIP top BLUMOTION +45	79B9658			280,00
Clip Expando	174E6100.01			30,00
Clip	173L6100			25,00

			.	.
Clip	( ) 175H3100 MPL V500		.	40,00
Clip	( ) 177H3100E		.	65,00
250 955.1008D			.	30,00
(40) FLVO1SP			.	150,00
600	( ) (20) SGV60VM20CP			1 100,00
700	( ) SGV70VCP			1 200,00
800	( ) (20) SGV80VM20CP			1 200,00
900	( ) (20) SGV90VM20CP			1 300,00
600	( ) (20) SGV60PM20CP			1 000,00
800	( ) (20) SGV80PM20CP			1 200,00
900	( ) SGV90PM20CP			1 300,00
600	VA600		.	1 100,00
600	VA600M20			1 100,00

700 (20) VA700			1 300,00
800 VA800M20			1 400,00
900 VA900M20			1 500,00