

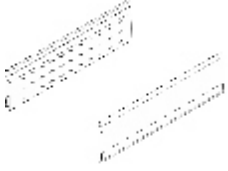

























25.10.2022





BOXIDE L450 R+L	Z37H418S.E		1 386,00
BOXIDE L500 R+L	Z37H468S.E		1 617,00
HF	(HGR) (20) 20F8001		207,90
HF	(HGR) (20) 20F8001		207,90
HF	20F8001 L		242,55
HF	20F8001 R		242,55
HF	480-570 () 20F3201.01		1 501,50
HF	560-710 () 20F3501.01TE-HEB V40 NI		1 651,65
HF	760-1040 () 20F3901.01		1 732,50



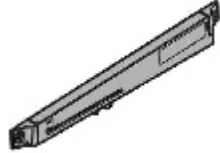

HF28	/ LF=9000-17,250(SERVO-DRIVE) 20F2801.05		.	2 656,50
HK	20 8001.02 L		.	231,00
HK	, 20K8001.02 L SW		.	242,55
HK	20K8001.02 R		.	231,00
HK	, 20K8001.02 R SW		.	242,55
HK	blum 20 9001. L.L		.	75,08
HK	blum 20K9001.BL.R		.	75,08
HK	/ KM 0750-2500 (SERVO-DRIVE) (20K2501.05		.	2 252,25
HK	/ KM 1500-4900 (SERVO-DRIVE) (20K2701.05		.	2 367,75
HK	/ KM 3200-9000 SERVODRIVE 20K2901.05		.	3 234,00
HK	/ TIP-ON KM 3200-7800 20K2901T		.	4 158,00
HK	/ TIP-ON KM 750-2500 20K2501T		.	2 656,50



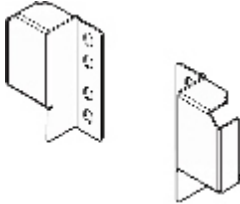

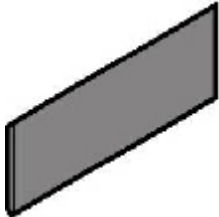
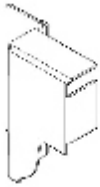
HK	/	1500-4900	SERVODRIVE 20K2701.05		.	2 367,75
HK-S		20K8A01			.	115,50
HK-S		20K8A01	ABD L V40SEIW		.	173,25
HK-S			20K9001ABD V500SEIW		.	0,00
HK-S		20 8 01 R			.	115,50
HK-S			20K8A01 ABD R V40SEIW		.	173,25
HK-S	/	(C) c TIP ON	20K2C01T		.	1 270,50
HK-S	/	()	20 2 01.02		.	1 270,50
HK-S	/	()	c TIP ON 20K2E01T		.	1 270,50
HK-S	/	()	(40) 20 2C01.02KRA FTSP 40 ZN		.	1 270,50
HK-XS			AVENTOS, (200) 20K5101			92,40

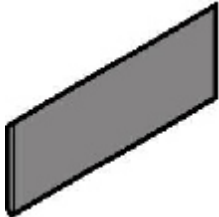



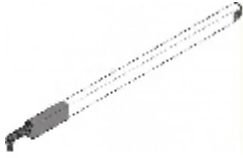
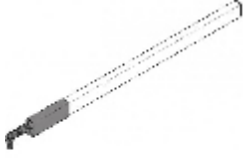
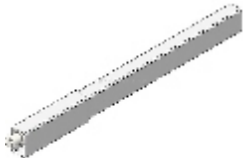
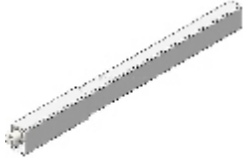

HK-XS	20K4101			92,40
HK-XS	/ 500-1500 20K1301			1 270,50
HK-XS	/ 800-1800 20K1501			1 270,50
HK-XS	/ TIP-ON, 800-1600 20K1501T			1 270,50
HL 25	SERVODRIVE 20L2501.05			1 848,00
HL 27	SERVODRIVE 20L27017.05			1 963,50
HL	20 20L8001.02.L			115,50
HL	20L8001.01.L (. .)			150,15
HL	20 20L8001.02 R			115,50
HL	20L8001.01.R (. .)			150,15
HL	200 20Q003A01			34,65



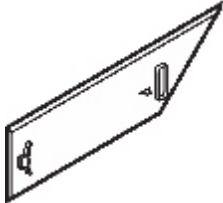



HL	=450-580	20L3901.06.L			1 501,50
HL	=450-580	20L3901.06.R			1 501,50
HL		L=1061	20Q1061UA		924,00
HS		20 20S8001.L			115,50
HS		20 20S8001.R			115,50
HS		20Q0003.03			17,32
METABOX	450	ZRG.421V.ID.CW/C			115,50
METABOX 450*150 320H4500C					693,00
METABOX 450*150 320H4500C					693,00



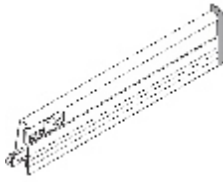

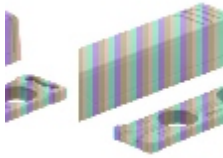

METABOX 450*86 320M4500C			519,75
METABOX blumotion metabox Z70.0320			312,00
METABOX BLUM ZAA.3500.BL			11,55
METABOX R+L ZSF.1700			69,30
METABOX - H(150), . 25 , -450, , 320H4502C L			0,00
METABOX - H(150), . 25 , -450, , 320 4502C R			0,00
METABOX ZRR.8000.01			40,42
METABOX , . ,25 , 450 , 320M4501 L			0,00
METABOX , . ,25 , 450 , 320M4501 RE			0,00
MOVENTO T51.7601.L			138,60
MOVENTO T51.7601.R			138,60
MOVENTO 450 , 40 , TIP ON 760H4500M			2 887,50
MOVENTO 450 , 40 , TIP ON 760H4500T			3 465,00
MOVENTO TIP-ON L3 350-750 / (20) T60L7540 TOB R+LV1R737			1 270,50
TANDEMBOX 450 R+L 358N4502S			0,00
TANDEMBOX Antaro Z36.00804			11,55
TANDEMBOX Antaro Z36.00801			11,55
TANDEMBOX Antaro Z36D00802 R			51,98
TANDEMBOX Antaro Z36D00802 L			51,98
TANDEMBOX Antaro () . . ZRR.5200			225,22







TANDEMBOX Antaro ZAA.532C.BLABDV1000SEIW	Intivo	BLUM			17,32
TANDEMBOX Antaro V50 W	D . R+L	(50) Z30D000S HO-R L+R			254,10
TANDEMBOX Antaro	N . R+L	Z30N000S.04			173,25
TANDEMBOX Antaro V50 W	. R+L	(50) Z30M000S.04HO-RL			150,15
TANDEMBOX Antaro	1 . . R+L	(50) Z30B000S.04			288,75
TANDEMBOX Antaro HO-RW MP W	1 . R+L	(50) Z30C000S			288,75
TANDEMBOX Antaro	. T51.1700.04 L				57,75
TANDEMBOX Antaro	. T51.1700.04 R				57,75
TANDEMBOX Antaro V1 SEIW	N 450 ,	.R+L 358N4502SA Z R+L			2 021,25
TANDEMBOX Antaro R+L V1 SEIW	N 500 ,	.R+L (16) 378N5002SA Z			2 079,00



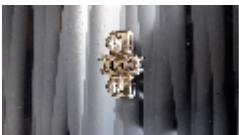

TANDEMBOX Antaro ZRG.387RSIC SW L	450 ()					288,75
TANDEMBOX Antaro ZRG.387RSIC SW R	450 ()					288,75
TANDEMBOX Antaro ZRG.437RSIC SW L	500 ()					300,30
TANDEMBOX Antaro ZRG.437RSIC SW R	500 ()					300,30
TANDEMBOX Antaro/intivo L+R V1 SEIW	450 ,	.R+L	378M4502SA Z			1 732,50
TANDEMBOX Antaro/intivo V20SEIW	500 ,	.R+L	378M5002SA R+L			1 848,00
TANDEMBOX Tip-on blum, TOB R+L V1R735	S1,NL=270-349m,10-20 ,	-	T60B3130			1 097,25
TANDEMBOX	450		ZRG.396V.ICREL LAE100/WA/G			173,25
TANDEMBOX	500		ZRG.446V.IC			173,25
TANDEMBOX WELLE V 40 S	Tip-on 1400 ,	.6 ,	1118 T60L1118W			346,50

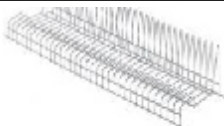
TANDEMBOX	R+L ZAA.230N.BL				20,79
TANDEMBOX	"N" R+L Z30N000S.04				173,25
TANDEMBOX	D R+L (50) Z30D000S HO R R+L V50R906				254,10
TANDEMBOX	R+L , Z30M000S.04				138,60
TANDEMBOX	R+L , Z30M000S.04				138,60
TANDEMBOX	R+L 2 Z30D000S				254,10
TANDEMBOX	R+L Z30B000S				138,60
TANDEMBOX	R+L c 1 Z30B000S.04				127,05
TANDEMBOX MP ZN	blumotion 30 , 500 ,R+L 578.5001B K R+L				1 674,75
TANDEMBOX	. INSERTA ZSF.3902				115,00
TANDEMBOX	. ZIF.70M0 FRO R+L V1R737	0			519,75
TANDEMBOX	. ZSF 3502.02FROB V500 BL				58,00
TANDEMBOX	ZIF.7007				750,00
TANDEMBOX	ZRG.000E3				11,55
TANDEMBOX	450 R+L 378M4502S				1 501,50
TANDEMBOX	450 R+L (20) 378N4502S				1 732,50

TANDEMBOX	500	R+L	(20) 378N5002S			1 848,00
TANDEMBOX	500	R+L	(20) 378M5002S			1 732,50
TIP ON TIP-AP 250SCEIW			(20/32) 956A1201			173,25
TIP ON TIP-AP 250R736			(20/32) 956A1201			173,25
TIP ON TIP-AP 250R736			(20/17) 956.1201			115,50
TIP ON			956A1002TIP-ON 250R736			496,65
TIP-ON			955.1008 HPL-KL 250 BL			35,00
TIP-ON			955.1008D HPL-DR 250 NI			23,10
TIP-ON TIP-ON 250R 736			956 1002			496,65
TIP-ON 250SEIW			956.1002TIP ON			381,15
			BLUM (HF*HS*HL) . 20F9001.BL			60,00
			.HS*HK*HL 20S4201			138,60
			Clip 110 (86 .) 70T3553			46,20
. BLUMOTION	170 973 6000					184,80
			CLIP TOP (11,55
70.1503.BPABD PR1000 NI						

	1/2	. 107,120	. 70.1663	11,55
				
	1/2	. 107,120	. 70.1663	11,55
				
	170	. 973A6000		184,80
1000 NI	. Clip top B(. 70T3504 TO-AB	16,94
		71B3550 70T3504		11,55
				
CLIP top BLUMOTION 110		71B3550		335,00
				
CLIP top BLUMOTION 110		(250) 71B3750		335,00
				
CLIP top BLUMOTION	. 95	79B9550 MB V50 NI		635,25
CLIP top	110		70T3550.TL	173,25
				
Clip +45°		78 5550		277,20
Clip 120°		70T5550.T		184,80
				

Clip 170 71T6550		.	288,75
Clip t. 110 . . . 71T3550 MB V250 NI		.	162,00
. Clip top 78Z5500T			335,00
CLIP top BLUMOTION +45 79B9658			519,75
Clip Expando 174E6100.01			35,00
Clip 173L6100 MPL V500 NI		.	30,00
(40) FLVO1SP		.	207,90
1000 () (20) SVG100VCP		.	2 079,00
600 () (20) SGV60VM20CP			1 559,25
700 () SGV70VCP			1 674,75
800 () (20) SGV80VM20CP			1 674,75
1000 () SGV100PCP		.	2 079,00
600 () (20) SGV60PM20CP			1 559,25

700	() SGV70PCP		1 674,75
800	() (20) SGV80PM20CP		1 674,75
1000	VA1000		2 425,50
700	(20) VA700		1 848,00
800	VA800M20		2 079,00
600	VP600M20		924,00
800	VP800M20		1 039,50