

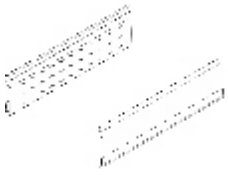





































10.03.2021



BOXIDE L450 R+L	Z37H418S.E			1 200,00
BOXIDE L500 R+L	Z37H468S.E			1 400,00
HF	(HGR) (20) 20F8001			170,00
HF	(HGR) (20) 20F8001			170,00
HF	20F8001 L			180,00
HF	20F8001 R			180,00
HF	480-570 ( ) 20F3201.01			1 300,00
HF	560-710 ( ) 20F3501.01TE-HEB V40 NI			1 350,00
HF	700-900 ( ) 20F3801.01T E-HEB V40			1 400,00
HF	760-1040 ( ) 20F3901.01			1 450,00
HF22 20 ZN	/ LF=2.600-5.550 ( SERVO-DRIVE) 20F2201.05KR AFTSP			2 000,00
HF25 20 ZN	/ LF=5.350-10.150 ( SERVO-DRIVE) ( 20F2501.05KRAFTSP			2 100,00



HF28	/ LF=9000-17,250( SERVO-DRIVE) 20F2801.05		.	2 300,00
HK	20 8001.02 L		.	200,00
HK	20K8001.02 R		.	200,00
HK	blum 20 9001. L.L		.	60,00
HK	blum 20K9001.BL.R		.	60,00
HK	/ KM 0750-2500 ( SERVO-DRIVE) ( 20K2501.05		.	1 800,00
HK	/ KM 3200-9000 SERVODRIVE 20K2901.05		.	2 800,00
HK	/ TIP-ON KM 0750-2500 20K2501T		.	1 800,00
HK	/ 1500-4900 SERVODRIVE 20K2701.05		.	1 800,00
HK-S	20K8A01		.	100,00
HK-S	20K8A01 ABD L V40SEIW		.	150,00

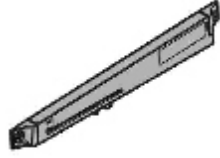

HK-S	20 8 01 R		.	100,00
HK-S	20K8A01 ABD R V40SEIW		.	150,00
HK-S	/ (C) c TIP ON 20K2C01T		.	900,00
HK-S	/ ( ) 20 2 01.02		.	900,00
HK-S	/ ( ) c TIP ON 20K2E01T		.	950,00
HK-S	/ ( ) (40) 20 2C01.02KRA FTSP 40 ZN		.	850,00
HK-XS	AVENTOS, (200) 20K5101			80,00
HK-XS	20K4101			80,00
HK-XS	/ 500-1500 20K1301			1 000,00
HK-XS	/ 800-1800 20K1501		.	1 000,00
HK-XS	/ TIP-ON 500-1500 20K1301T		.	1 100,00

HK-XS	/ TIP-ON, 800-1600 20K1501T		.	1 100,00
HL 25	SERVODRIVE 20L2501.05		.	1 600,00
HL 27	SERVODRIVE 20L27017.05		.	1 700,00
HL	20 20L8001.02.L		.	100,00
HL	20L8001.01.L ( . . )		.	130,00
HL	20 20L8001.02 R		.	100,00
HL	, 20L8001.01.R ( . . )		.	130,00
HL	. 200 20Q003A01		.	30,00
HL	=450-580 20L3901.06.L		.	1 300,00
HL	=450-580 20L3901.06.R		.	1 300,00
HL	. L=1061 20Q1061UA		.	800,00

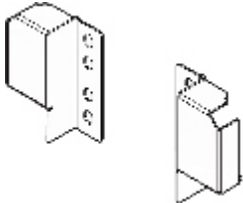
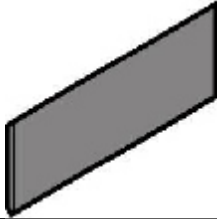
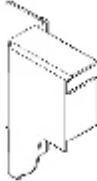
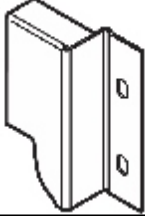

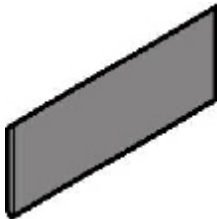

HS	20 20S8001.L			100,00
HS	20 20S8001.R			100,00
HS	20Q0003.03			15,00
HS	20S3501.06L			1 450,00
HS	20S3501.06 R			1 450,00
HS	/ 4.0-8.0	SERVODRIVE 20S2G01.05		1 900,00
HS	/ 6-13.5	SERVODRIVE 20S2H01.05		1 900,00
HS	1061	20Q1061UN		550,00
METABOX	450	ZRG.421V.ID.CW/C		100,00

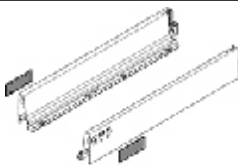
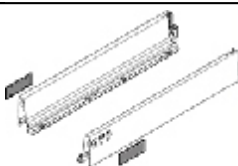
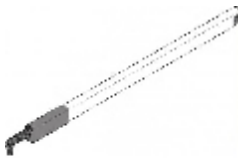
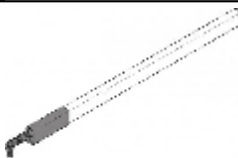
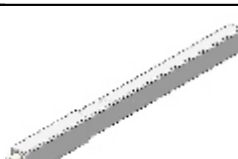



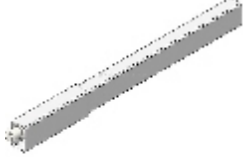

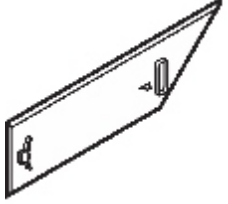
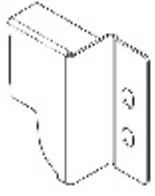
METABOX 450*150 320H4500C		.	600,00
METABOX 450*150 320H4500C		.	600,00
METABOX 450*86 320M4500C		.	450,00
METABOX blumotion    metabox    Z70.0320		.	270,00
METABOX                    BLUM                    ZAA.3500.BL		.	10,00
METABOX                    R+L ZSF.1700		.	60,00
METABOX    -    H(150 ),    .    25    ,    -450,    ,    320H4502C L		.	0,00
METABOX    -    H(150 ),    .    25    ,    -450,    ,    320 4502C R		.	0,00
METABOX                    ZRR.8000.01		.	35,00
METABOX                    ,    .    ,25    ,    450    ,    320M4501 L		.	0,00
METABOX                    ,    .    ,25    ,    450    ,    320M4501 RE		.	0,00
MOVENTO                    T51.7601.L		.	120,00
MOVENTO                    T51.7601.R		.	120,00
MOVENTO                    450    ,    40    ,    TIP ON 760H4500M		.	1 900,00
MOVENTO                    450    ,    40    ,    TIP ON 760H4500T		.	2 500,00
MOVENTO                    TIP-ON    L3 350-750    /    (20) T60L7540 TOB R+LV1R737		.	1 100,00



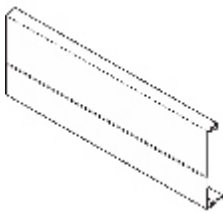

TANDEMBOX	450	R+L	358N4502S			0,00
TANDEMBOX Antaro			Z36.00804			10,00
TANDEMBOX Antaro			Z36.00801			10,00
TANDEMBOX Antaro Z36D00802 R						45,00
TANDEMBOX Antaro L			Z36D00802			45,00
TANDEMBOX Antaro	( )		ZRR.5200			195,00
TANDEMBOX Antaro	Intivo		BLUM			15,00
TANDEMBOX Antaro	D . R+L		(50) Z30D000S HO-R L+R			220,00
TANDEMBOX Antaro	N . R+L		Z30N000S.04			150,00
TANDEMBOX Antaro	. R+L		(50) Z30M000S.04HO-RL			130,00
TANDEMBOX Antaro	. R+L		(50) Z30M000S.04HO-RV50SEIW			130,00
TANDEMBOX Antaro	1 . . R+L		(50) Z30B000S.04			250,00
TANDEMBOX Antaro	1 . R+L		(50) Z30C000S			250,00
TANDEMBOX Antaro			T51.1700.04 L			50,00

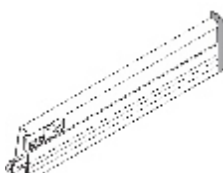

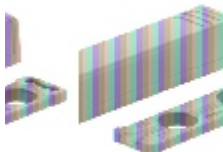



TANDEMBOX Antaro		T51.1700.04 R				50,00
TANDEMBOX Antaro SEIW	450	, .R+L	378M4502SA Z L+R V1			1 500,00
TANDEMBOX Antaro V20SEIW	500	, .R+L	378M5002SA R+L			1 600,00
TANDEMBOX Antaro	450	, .R+L	358M4502SA Z V1 SEIW			1 500,00
TANDEMBOX Antaro V1 SEIW	N 450	, .R+L	358N4502SA Z R+L			1 750,00
TANDEMBOX Antaro R+L V1 SEIW	N 500	, .R+L (16)	378N5002SA Z			1 800,00
TANDEMBOX Antaro ZRG.387RSIC SW L	450	( )				250,00
TANDEMBOX Antaro ZRG.387RSIC SW R	450	( )				250,00
TANDEMBOX Antaro ZRG.437RSIC SW L	500	( )				260,00











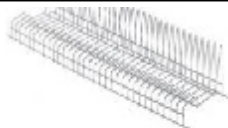

TANDEMBOX Antaro ZRG.437RSIC SW R	500 ( )		260,00
TANDEMBOX Intivo SEIW	500 , .R+L 378M5002SA Z R+L V1		1 600,00
TANDEMBOX Tip-on blum, TOB R+L V1R735	S1,NL=270-349m,10-20 , - T60B3130		950,00
TANDEMBOX	450 ZRG.396V.ICREL LAE100/WA/G		150,00
TANDEMBOX	500 ZRG.446V.IC		150,00
TANDEMBOX WELLE V 40 S	Tip-on 1400 , .6 , 1118 T60L1118W		300,00
TANDEMBOX	R+L ZAA.230N.BL		18,00
TANDEMBOX	"N" R+L Z30N000S.04		150,00
TANDEMBOX	D R+L (50) Z30D000S HO R R+L V50R906		220,00
TANDEMBOX	R+L , Z30M000S.04		120,00
TANDEMBOX	R+L 2 . Z30D000S		220,00
TANDEMBOX	R+L Z30B000S		120,00
TANDEMBOX	R+L c 1 . Z30B000S.04		110,00
TANDEMBOX MP ZN	blumotion 30 , 450 ,R+L 578.4501B K R+L		1 350,00

TANDEMBOX MP ZN	blumotion 30	500	R+L	578.5001B K R+L			1 450,00
TANDEMBOX	INSERTA	ZSF.3902					100,00
TANDEMBOX	ZIF.70M0	FRO R+L	V1R737			0	450,00
TANDEMBOX	ZSF 3502.02	FROB	V500 BL				50,00
TANDEMBOX	Z31A1081A						800,00
TANDEMBOX	ZIF.7007						450,00
TANDEMBOX	ZRG.000E3						10,00
TANDEMBOX	450	R+L	378M4502S				1 300,00
TANDEMBOX	450	R+L	(20) 378N4502S				1 500,00
TANDEMBOX	500	R+L	(20) 378N5002S				1 600,00
TANDEMBOX	500	R+L	(20) 378M5002S				1 400,00
TIP ON TIP-AP 250SCEIW				(20/32) 956A1201			150,00
TIP ON TIP-AP 250R736				(20/32) 956A1201			150,00
TIP ON TIP-AP 250R736				(20/17) 956.1201			100,00
TIP-ON	955.1008	HPL-KL	250 BL				30,00

TIP-ON	955.1008D HPL-DR 250 NI			20,00
TIP-ON	- 956 1002			430,00
TIP-ON	956A1002			450,00
TIP-ON	956.1002TIP ON			330,00
TIP-ON	250SEIW			300,00
TIP-ON	956.1002TIP-ON 250R736			
	BLUM (HF*HS*HL) . 20F9001.BL			50,00
	.HS*HK*HL 20S4201			100,00
	Clip 110 ( 86 .) 70T3553			40,00
. BLUMOTION	170 973 6000			160,00
	CLIP TOP (			10,00
70.1503.BPABD PR1000 NI				
	1/2 . 107,120 . 70.1663			10,00
	170 . 973A6000			160,00
	. Clip top B( . 70T3504 TO-AB			15,00
1000 NI				
CLIP top BLUMOTION 110	71B3550			250,00

CLIP top BLUMOTION 110 (250) 71B3750			270,00
CLIP top BLUMOTION 110 71B3650			270,00
CLIP top BLUMOTION . 95 79B9550 MB V50 NI			490,00
CLIP top 110 , , 70T3550.TL			150,00
Clip +45° , 78 5550			240,00
Clip 120° 70T5550.T			160,00
Clip 170 71T6550			250,00
Clip t. 110 . . 71T3550 MB V250 NI			140,00
Clip (50) 78T9550.TL			300,00
. Clip top 78Z5500T			290,00
CLIP top BLUMOTION +45 79B9658			450,00

Clip Expando 174E6100.01				30,00
Clip 173L6100				25,00
Clip ( ) 175H3100 MPL V500			.	50,00
250 955.1008D			.	30,00
(40) FLVO1SP			.	150,00
1000 ( ) (20) SVG100VCP			.	1 500,00
450 ( ) SGV45VM20 CP			.	1 200,00
700 ( ) SGV70VCP				1 200,00
800 ( ) (20) SGV80VM20CP				1 200,00
900 ( ) (20) SGV90VM20CP				1 300,00
1000 ( ) SGV100PCP			.	1 500,00
450 ( ) SGV45PM20 CP			.	1 000,00
700 ( ) SGV70PCP				1 100,00
800 ( ) (20) SGV80PM20CP				1 200,00

900	( ) SGV90PM20CP		1 300,00
1000	VA1000		1 700,00
600	VA600		1 100,00
700	(20) VA700		1 300,00
800	VA800M20		1 400,00
900	VA900M20		1 500,00
450	VP450M20		600,00